

**1**

**Resistor - Weerstand - Résistance - Widerstand - Resistencia - Motstand - Vastus - Resistenze**

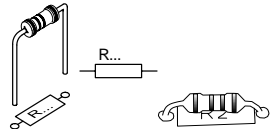

R1,R2, R3, R4: 10K	(Brown, Black, Orange) -(Bruin, Zwart, Oranje) -(Brun, Noir, Orange) -(Braun, Schwarz, Orange) -(Brun, Svart, Orange) -(Ruskea, Musta, Oranssi) -(Marrón, Negro, Naranjado) -(Castanho, Preto, Laranja) -(Marrone, Nero, Aranciato)
R5, R6, R7, R8 : 1K	(Brown, Black, Red) -(Bruin, Zwart, Rood) -(Brun, Noir, Rouge) -(Braun, Schwarz, Rot) -(Brun, Svart, Röd) -(Ruskea, Musta, Punainen) -(Marrón, Negro, Rojo) -(Castanho, Preto, Encarnado) -(Marrone, Nero, Rosso)
R9, R10 : 100K	(Brown, Black, Yellow) -(Bruin, zwart, Geel) -(Brun, Noir, Jaune) -(Braun, Schwarz, Gelb) -(Brun, Svart, Gul) -(Ruskea, Musta, Keltainen) -(Marrón, Negro, Amarillo) -(Castanho, Preto, Amarelo) -(Marrone, Nero, Giallo)
R11 : 0	(Black) -(Zwart) -(Noir) -(Schwarz) -(Svart) -(Musta) -(Negro) -(Preto) -(Nero)

**2**

**DIOD**

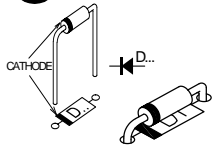

◇ D1 : BAT85  
Watch the polarity !  
Att. à la polarité !

**3**

**ZENER DIODES**

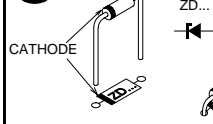

◇ ZD1 : 2V4  
◇ ZD2 : 2V4  
◇ ZD3 : 3V0  
Watch the polarity !  
Attention à la polarité !

**4**

**IC SOCKET**

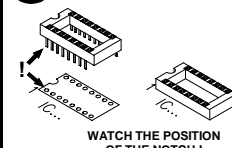

◇ IC1 : 14P  
WATCH THE POSITION OF THE NOTCH !  
ATTENTION A LA POSITION DE L'ENCOCHE !

**5**

**PUSHBUTTON**

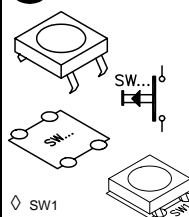

◇ SW1

**6**

**LEDs**

Watch the polarity !  
Attention à la polarité !

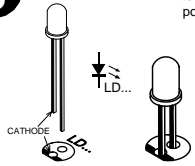

**Open** : red / rood / rouge / rot / röd / punainen / rojo / encarnado / rosso  
**Polarity OK** : green / groen / vert / grün / grön / vihreä / verde  
**Polarity INVERTED** : red / rood / rouge / rot / röd / punainen / rojo / encarnado / rosso  
**Short** : red / rood / rouge / rot / röd / punainen / rojo / encarnado / rosso

**7**

**TRANSISTORS**

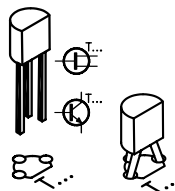

◇ T1 : BC557  
◇ T2 : BC547

**8**

**ELECTROLYTIC CAPACITORS**

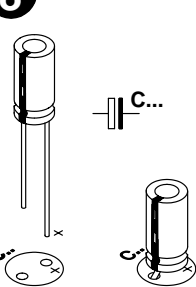

Watch the polarity !  
Attention à la polarité !

◇ C1 : 47µF

**9**

**IC SOCKET AND IC**

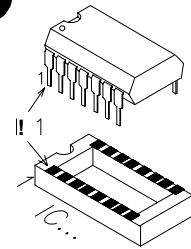

WATCH THE POSITION OF THE NOTCH !  
ATTENTION A LA POSITION DE L'ENCOCHE !

◇ IC1 : LM324, LM224, LM124 or eq.

**10**

**PREPARING THE TESTLEADS**

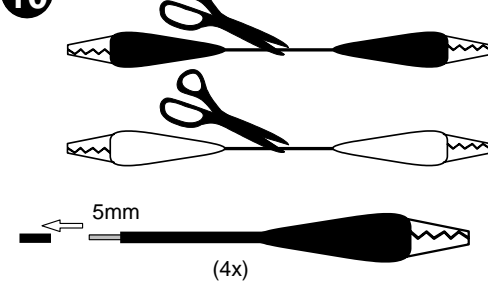

(4x)

**11**

**CUT**

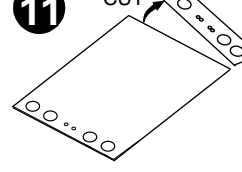

**12**

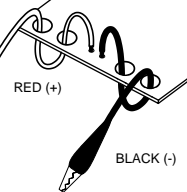

**13**

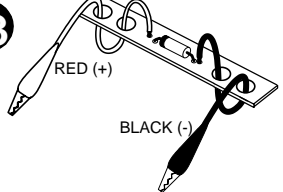

**14**

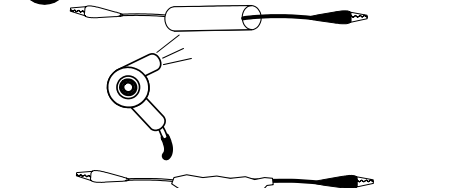

**15**

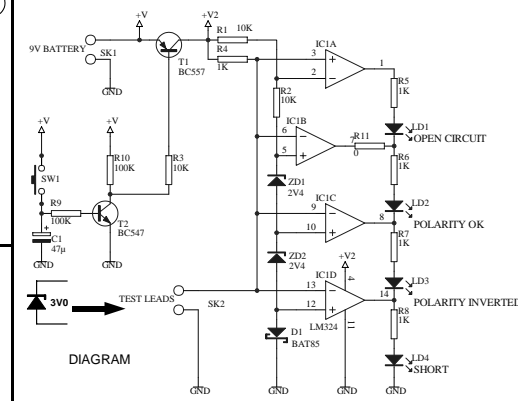
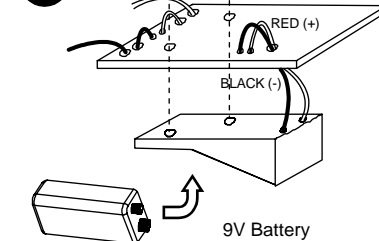

DO NOT ATTEMPT TO TEST LIVE WIRES / NIET METEN OP SPANNINGSVOEREND KABELS / N'ESSAYEZ PAS DE TESTER DES FILS SOUS TENSION / TESTEN SIE NUR SPANNUNGSLÖSE LEITER / NUNCA COMPRUEBE CABLES BAJO TENSION / NETESTUJTE KABLY POD NAPĚTÍM / TESTA ALDRIG STRÖMFORANDE KABLAR / MÁ IKKE ANVEND ES P KABLER, SOM ER STRØMFORANDE / ALÄ KOSKAAN KOESTA JÄNNITTEELLISIÄ JOHTIMIA / PRECAUÇÃO: NÃO TENTAR TESTAR CIRCUITOS ATIVOS (CIRCUITOS COM CORRENTE ALTERNA) / NON TESTARE I CAVI SOTTO TENSIONE!