

Soldering - Soldieren - Soudage - Lötten - Soldadura - Lötning - Juottaminen - Saldatura - Solda



max. 40W

Component side - componentenzijde - Côte composants - Bauteilseite - Lado de los componentes

START **1** Jumper

\varnothing 7x

2 LEDs

Watch the polarity!
Attention à la polarité!

\varnothing 30 X (Red, Red, Rouge, Rot, Rosso)

\varnothing 20 X Yellow-Green, Jaune-Vert, Grün, Green, Vert, Grün, Grün

\varnothing 10x Green, Green, Vert, Grün, Grün

CATHODE LD..

Soldering - Soldieren - Soudage - Lötten - Soldadura - Lötning - Juottaminen - Saldatura - Solda

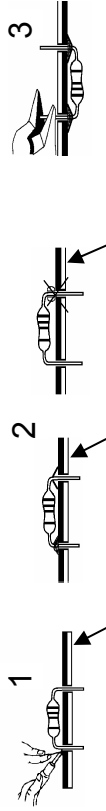

max. 40W

Component side - componentenzijde - Côte composants - Bauteilseite - Lado de los componentes

START **1** Resistor - Weerstand - Resistencia - Widerstand - Resistenzia - Motstand - Vaetus - Resistenz

\varnothing R1 : 100

\varnothing R2 : 4K7

\varnothing R3 : 68K

\varnothing R4 : 4M7

\varnothing R5 : 10K

R..

(Brown, Black, Brown) - (Brun, Noir, Brun) - (Braun, Schwarz, Braun) - (Bron, Szwary, Bron) - (Ruska, Musta, Ruskea) - (Marrón, Negro, Marrón) - (Castanho, Preto, Castanho) - (Marrone, Nero, Marrone)

(Yellow, Purple, Red) - (Gelb, Paars, Rood) - (Jaune, Violet, Rouge) - (Gelb, Violet, Rot) - (Gul, Lila, Rood) - (Keltainen, Purpura, Punainen) - (Amarillo, Morado, Rojo) - (Amarelo, Viola, Rosso)

(Blue, Grey, Orange) - (Blaauw, Grijs, Oranje) - (Bleu, Gris, Orange) - (Blaü, Grau, Orange) - (Blü, Gräu, Orange) - (Sininen, Harmaa, Oranssi) - (Azul, Gris, Naranja) - (Azul, Cinzento, Laranja) - (Blu, Grigio, Aranciate)

(Yellow, Purple, Green) - (Gelb, Paars, Grün) - (Jaune, Violet, Vert) - (Gelb, Violet, Grün) - (Gul, Lila, Grün) - (Keltainen, Purpura, Vihreä) - (Amarillo, Morado, Verde) - (Amarelo, Viola, Verde)

(Brown, Black, Orange) - (Brun, Zwart, Oranje) - (Brun, noir, Orange) - (Braun, Schwarz, Orange) - (Bron, Szwary, Orange) - (Ruskea, Musta, Oranssi) - (Marrón, Negro, Naranja) - (Castanho, Preto, Laranja) - (Marrone, Nero, Aranciate)

- \varnothing R6 ... R8 : 4K7
 - \varnothing R9 ... R15 : 2K2
 - \varnothing R16 ... R22 : 1K
 - \varnothing R23, R24 : 5K6
- (Yellow, Purple, Red) - (Gelb, Paars, Rood) - (Jaune, Violet, Rouge) - (Gelb, Violet, Rot) - (Gul, Lila, Rood) - (Keltainen, Purpura, Punainen) - (Amarillo, Morado, Rojo) - (Amarelo, Viola, Rosso)
- (Red, Red, Red) - (Rood, Rood, Rood) - (Rouge, Rouge, Rouge) - (Rot, Rot, Rot) - (Rood, Rood, Rood) - (Punainen, Punainen, Punainen) - (Rojo, Rojo, Rojo) - (Encarnado, Encarnado, Encarnado)
- (Brown, Black, Red) - (Brun, Zwart, Rood) - (Brun, Noir, Rouge) - (Braun, Schwarz, Rot) - (Brun, Szwary, Rood) - (Ruskea, Musta, Punainen) - (Marrón, Negro, Rojo) - (Castanho, Preto, Encarnado) - (Marrone, Nero, Rosso)
- (Green, Blue, Red) - (Green, Blauw, Rood) - (Vert, Bleu, Rouge) - (Grün, Blau, Rot) - (Grün, Blü, Röd) - (Vihreä, Sininen, Punainen) - (Marrón, Azul, Rojo) - (Verde, Azul, Encarnado) - (Verde, Blü, Rosso)

4 Transistors

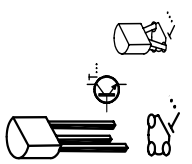

5 Switch

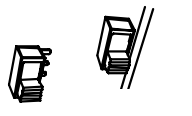

6 Trimmer

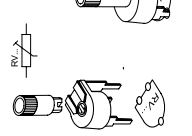

7 Electrolytic capacitors

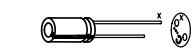

8 DC connector

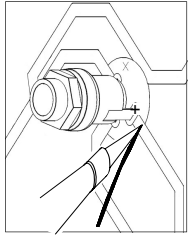
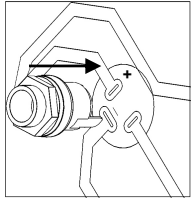
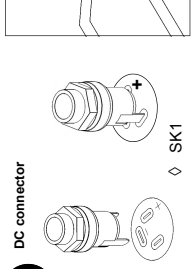

9 Microphone

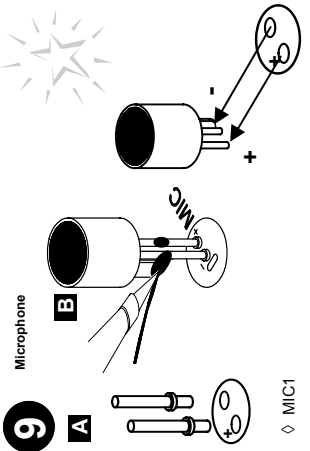

2 Diodes

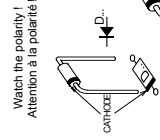

3 Zenerdiode

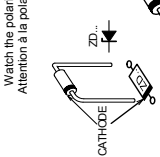

Battery

